



STANDARD 45G GUYED TOWER

ROHN 45G
The first. The original.



45G



GENERAL USE

The 45G is a true multi-use structure that provides excellent strength for applications up to 300'. It is offered with heavy steel round legs to satisfy a variety of needs under varied conditions.

FEATURES

- Completely hot-dip galvanized after fabrication
- Built on a 16 3/4" equilateral triangle design
- High strength tubular legs joined by Zig-Zag® cross members
- Each section contains all required nuts and bolts shipped with section
- Continuous solid round steel bracing

CAUTION

Mixing copies of ROHN towers with ROHN towers is dangerous and voids all engineering and warranty data supplied by ROHN. Materials used by others are not the same quality and have not been tested or engineered by ROHN. Mixing ROHN tower sections with non-ROHN products may cause tower failure or injury.

Per Rev G requirements, any structure greater than 10' requires a climber safety device. Please see page 65 for ordering information.



STANDARD 45G GUYED TOWER SECTIONS

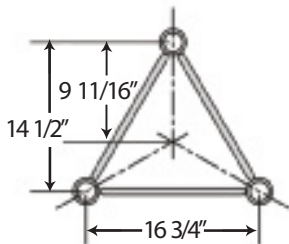

QUICK REFERENCE	
PARTS & ACCESSORIES	PAGES 63-65
GROUNDING INFORMATION	PAGE 66
FOUNDATION INFORMATION	PAGES 66-69

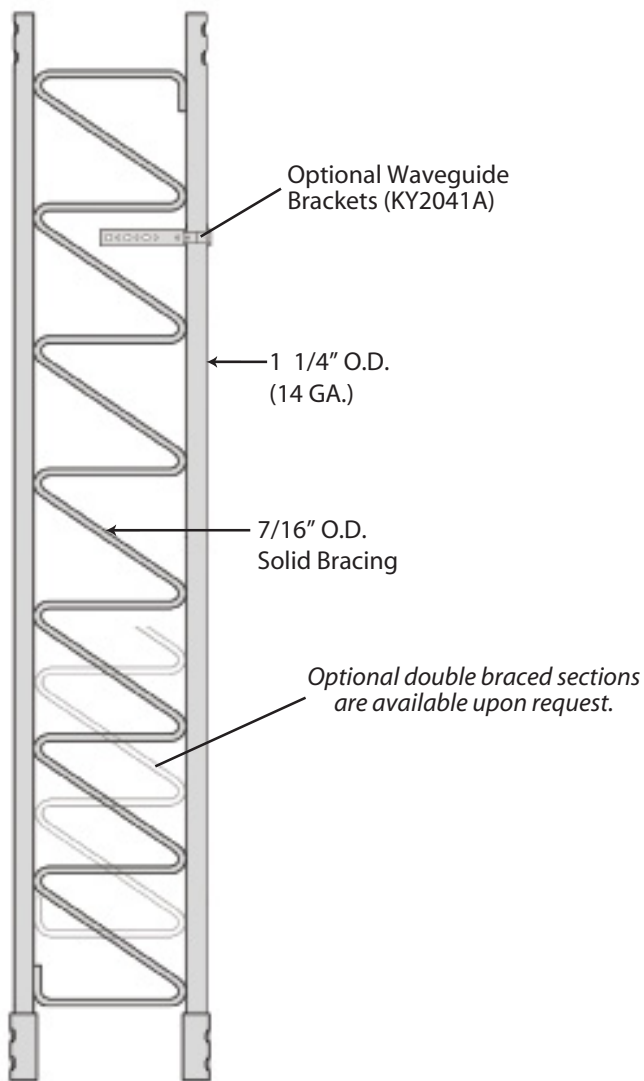

**STANDARD SECTION
45G - 10' Section**

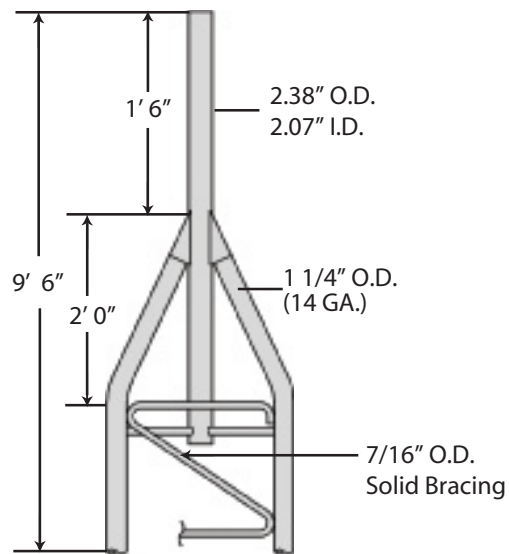

**STANDARD TOP SECTION
45AG2**

Additional 45G top sections are shown on page 63.

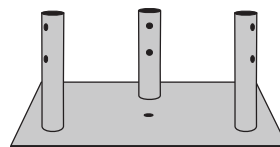

**CONCRETE BASE PLATE
BPC45G***

FOR USE WITH 3/4X12PP PIER PIN EMBEDDED IN CONCRETE.

Additional base sections are available, please see page 64.

* Towers mounted on these bases must be bracketed or guyed at all times. Temporary steel guying may also be necessary during installation and dismantling.



BUYERS GUIDE
STANDARD DESIGNS - 45G
90MPH REV. G [3-SECOND GUST]
70MPH REV. F [FASTEST MILE]

Design Criteria

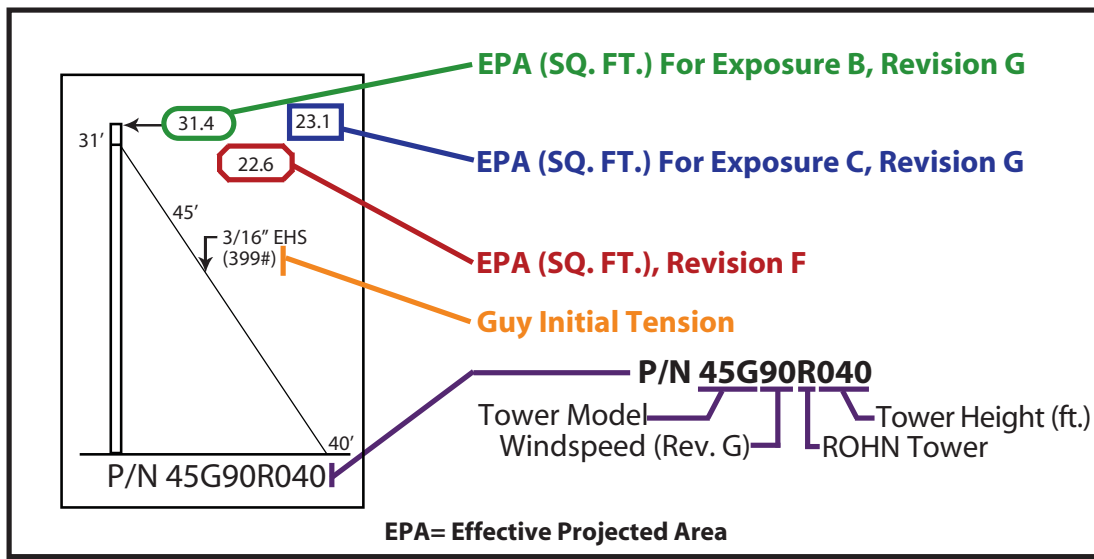

This document is to serve as a guide for sizing and purchasing the 45G tower. Tower and foundation installations should be performed by qualified and experienced personnel using assembly drawings provided with each tower.

DESIGN NOTES:

1. Tower designs are in accordance with ANSI/TIA-222-F and ANSI/TIA-222-G, Class I Structures, Topographic Category 1.
2. Design assumes towers are installed on level ground. Lower EPA values will apply for roof mounted towers or for sites located on unusual terrain.
3. Designs assume two 1/2" diameter lines on each tower face.
4. Anchor radius is from tower base to intersection of anchor rod with ground.
5. Guy chord lengths shown are based on level ground. Initial tensions for guys are shown in () in pounds at 60° Fahrenheit.
6. Antenna and mounts are assumed symmetrically placed at the tower top.

PARTS LIST NOTES:

1. Items listed are required for complete guyed towers.
2. Base and anchor foundations listed refer to standard foundation designations.
3. Guys provided with each standard tower are based on level ground conditions with an additional 6% length.
4. Rev G anchor grounding (AGK1GGX) and base grounding (BGK3GGX) are included with the tower material.
5. Assembly drawings and a safety package (P/N: ACWS) are included with each tower.
6. Parts lists are subject to change based on availability or revised design criteria.

FOR FOUNDATION INFORMATION, PLEASE SEE PAGES 66-69.

FOR GENERAL INSTALLATION INFORMATION, PLEASE SEE PAGES 147-153.



STANDARD DESIGN - 45G
90MPH REV. G, 70MPH REV. F

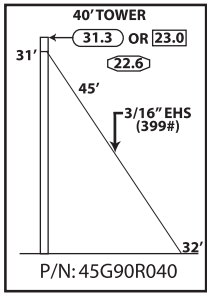

TOWER PARTS INCLUDED	45G	45AG2	BPC45G	GA45GD	FDNS	
					BASE	ANCHOR
	3	1	1	1	CB1G	AB2
GUYS & CONNECTIONS INCLUDED	3/16EHS	BG2142	5/16THH	1/2TBE&J	TBSAFETY	
	150'	6	6	3	3	
ANCHORS & GROUNDING INCLUDED	GAC3455TOP	AGK1GGX	BGK3GGX	CPC.5/.75	3/4x12PP	
	3	1	3	3	1	

40' ROHN 45G
All parts shown in table are included when ordering
Part No: 45G90R040

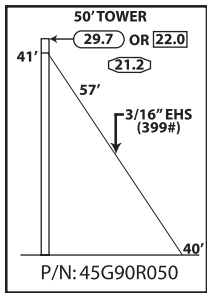

TOWER PARTS INCLUDED	45G	45AG2	BPC45G	GA45GD	FDNS	
					BASE	ANCHOR
	4	1	1	1	CB1G	AB2
GUYS & CONNECTIONS INCLUDED	3/16EHS	BG2142	5/16THH	1/2TBE&J	TBSAFETY	
	200'	6	6	3	3	
ANCHORS & GROUNDING INCLUDED	GAC3455TOP	AGK1GGX	BGK3GGX	CPC.5/.75	3/4x12PP	
	3	1	3	3	1	

50' ROHN 45G
All parts shown in table are included when ordering
Part No: 45G90R050

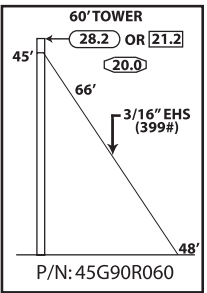

TOWER PARTS INCLUDED	45G	45AG2	BPC45G	GA45GD	FDNS	
					BASE	ANCHOR
	5	1	1	1	CB1G	AB2
GUYS & CONNECTIONS INCLUDED	3/16EHS	BG2142	5/16THH	1/2TBE&J	TBSAFETY	
	225'	6	6	3	3	
ANCHORS & GROUNDING INCLUDED	GAC3455TOP	AGK1GGX	BGK3GGX	CPC.5/.75	3/4x12PP	
	3	1	3	3	1	

60' ROHN 45G
All parts shown in table are included when ordering
Part No: 45G90R060

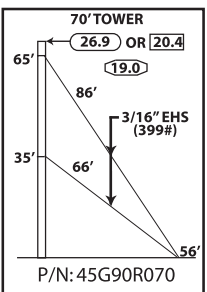

TOWER PARTS INCLUDED	45G	45AG2	BPC45G	GA45GD	FDNS	
					BASE	ANCHOR
	6	1	1	2	CB1G	AB2
GUYS & CONNECTIONS INCLUDED	3/16EHS	BG2142	5/16THH	1/2TBE&J	TBSAFETY	
	500'	12	12	6	3	
ANCHORS & GROUNDING INCLUDED	GAC3455TOP	AGK1GGX	BGK3GGX	CPC.5/.75	3/4x12PP	
	3	1	3	3	1	

70' ROHN 45G
All parts shown in table are included when ordering
Part No: 45G90R070

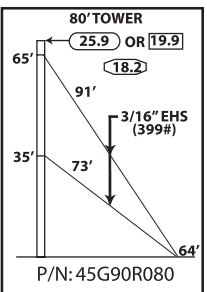

TOWER PARTS INCLUDED	45G	45AG2	BPC45G	GA45GD	FDNS	
					BASE	ANCHOR
	7	1	1	2	CB1G	AB2
GUYS & CONNECTIONS INCLUDED	3/16EHS	BG2142	5/16THH	1/2TBE&J	TBSAFETY	
	525'	12	12	6	3	
ANCHORS & GROUNDING INCLUDED	GAC3455TOP	AGK1GGX	BGK3GGX	CPC.5/.75	3/4x12PP	
	3	1	3	3	1	

80' ROHN 45G
All parts shown in table are included when ordering
Part No: 45G90R080





STANDARD DESIGN - 45G
90MPH REV. G, 70MPH REV. F

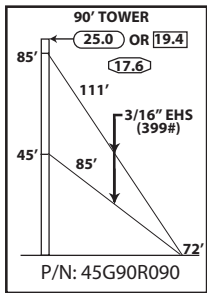

TOWER PARTS INCLUDED	45G	45AG2	BPC45G	GA45GD	FDNS	
					BASE	ANCHOR
	8	1	1	2	CB1G	AB2
GUYS & CONNECTIONS INCLUDED	3/16EHS	BG2142	5/16THH	1/2TBE&J	TBSAFETY	
	625'	12	12	6	3	
ANCHORS & GROUNDING INCLUDED	GAC3455TOP	AGK1GGX	BGK3GGX	CPC.5/.75	3/4x12PP	
	3	1	3	3	1	

90' ROHN 45G
All parts shown in table are included when ordering
Part No: 45G90R090

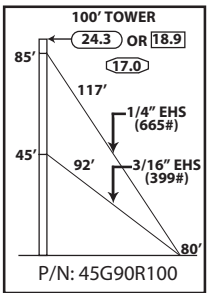

TOWER PARTS INCLUDED	45G	45AG2	BPC45G	GA45GD	FDNS		
					BASE	ANCHOR	
	9	1	1	2	CB1G	AB2	
GUYS & CONNECTIONS INCLUDED	3/16EHS	1/4EHS	BG2142	BG2144	5/16THH	3/8THH	1/2TBE&J
	300'	375'	6	6	6	6	6
ANCHORS & GROUNDING INCLUDED	GAC3455TOP	AGK1GGX	BGK3GGX	CPC.5/.75	3/4x12PP	TBSAFETY	
	3	1	3	3	1	3	

100' ROHN 45G
All parts shown in table are included when ordering
Part No: 45G90R100

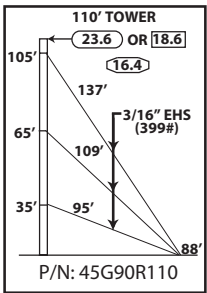

TOWER PARTS INCLUDED	45G	45AG2	BPC45G	GA45GD	FDNS	
					BASE	ANCHOR
	10	1	1	3	CB1G	AB2
GUYS & CONNECTIONS INCLUDED	3/16EHS	BG2142	5/16THH	1/2TBE&J	TBSAFETY	
	1100'	18	18	9	3	
ANCHORS & GROUNDING INCLUDED	GAC3455TOP	AGK1GGX	BGK3GGX	CPC.5/.75	3/4x12PP	
	3	1	3	3	1	

110' ROHN 45G
All parts shown in table are included when ordering
Part No: 45G90R110

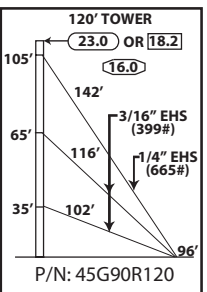

TOWER PARTS INCLUDED	45G	45AG2	BPC45G	GA45GD	FDNS		
					BASE	ANCHOR	
	11	1	1	3	CB1G	AB2	
GUYS & CONNECTIONS INCLUDED	3/16EHS	1/4EHS	BG2142	BG2144	5/16THH	3/8THH	1/2TBE&J
	700'	475'	12	6	12	6	9
ANCHORS & GROUNDING INCLUDED	GAC3455TOP	AGK1GGX	BGK3GGX	CPC.5/.75	3/4x12PP	TBSAFETY	
	3	1	3	3	1	3	

120' ROHN 45G
All parts shown in table are included when ordering
Part No: 45G90R120

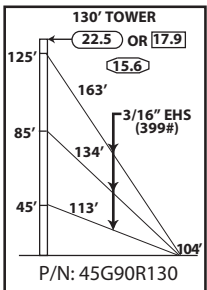

TOWER PARTS INCLUDED	45G	45AG2	BPC45G	GA45GD	FDNS	
					BASE	ANCHOR
	12	1	1	3	CB1G	AB2
GUYS & CONNECTIONS INCLUDED	3/16EHS	BG2142	5/16THH	1/2TBE&J	TBSAFETY	
	1325'	18	18	9	3	
ANCHORS & GROUNDING INCLUDED	GAC3455TOP	AGK1GGX	BGK3GGX	CPC.5/.75	3/4x12PP	
	3	1	3	3	1	

130' ROHN 45G
All parts shown in table are included when ordering
Part No: 45G90R130





STANDARD DESIGN - 45G 90MPH REV. G, 70MPH REV. F

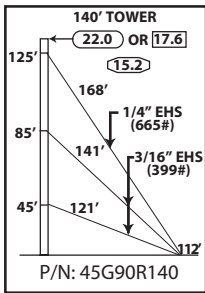

TOWER PARTS INCLUDED	45G	45AG2	BPC45G	GA45GD	FDNS		
					BASE	ANCHOR	
	13	1	1	3	CB1G	AB2	
GUYS & CONNECTIONS INCLUDED	3/16EHS	1/4EHS	BG2142	BG2144	5/16THH	3/8THH	1/2TBE&J
	850'	550'	12	6	12	6	9
ANCHORS & GROUNDING INCLUDED	GAC3455TOP	AGK1GGX	BGK3GGX	CPC.5/.75	3/4x12PP	TBSAFETY	
	3	1	3	3	1	3	

140' ROHN 45G
All parts shown in table are included when ordering
Part No: 45G90R140

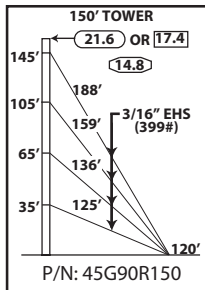

TOWER PARTS INCLUDED	45G	45AG2	BPC45G	GA45GD	FDNS	
					BASE	ANCHOR
	14	1	1	4	CB1G	AB2
GUYS & CONNECTIONS INCLUDED	3/16EHS	BG2142	5/16THH	1/2TBE&J	TBSAFETY	
	1950'	24	24	12	3	
ANCHORS & GROUNDING INCLUDED	GAC3455TOP	AGK1GGX	BGK3GGX	CPC.5/.75	3/4x12PP	
	3	1	3	3	1	

150' ROHN 45G
All parts shown in table are included when ordering
Part No: 45G90R150

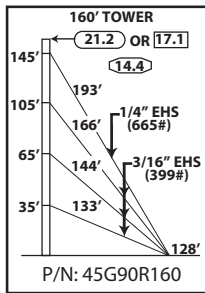

TOWER PARTS INCLUDED	45G	45AG2	BPC45G	GA45GD	FDNS		
					BASE	ANCHOR	
	15	1	1	4	CB1G	AB2	
GUYS & CONNECTIONS INCLUDED	3/16EHS	1/4EHS	BG2142	BG2144	5/16THH	3/8THH	1/2TBE&J
	1425'	625'	18	6	18	6	12
ANCHORS & GROUNDING INCLUDED	GAC3455TOP	AGK1GGX	BGK3GGX	CPC.5/.75	3/4x12PP	TBSAFETY	
	3	1	3	3	1	3	

160' ROHN 45G
All parts shown in table are included when ordering
Part No: 45G90R160

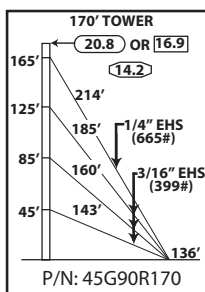

TOWER PARTS INCLUDED	45G	45AG2	BPC45G	GA45GD	FDNS		
					BASE	ANCHOR	
	16	1	1	4	CB1G	AB2	
GUYS & CONNECTIONS INCLUDED	3/16EHS	1/4EHS	BG2142	BG2144	5/16THH	3/8THH	1/2TBE&J
	1575'	700'	18	6	18	6	12
ANCHORS & GROUNDING INCLUDED	GAC3455TOP	AGK1GGX	BGK3GGX	CPC.5/.75	3/4x12PP	TBSAFETY	
	3	1	3	3	1	3	

170' ROHN 45G
All parts shown in table are included when ordering
Part No: 45G90R170

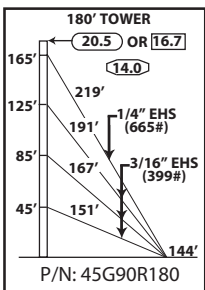

TOWER PARTS INCLUDED	45G	45AG2	BPC45G	GA45GD	FDNS		
					BASE	ANCHOR	
	17	1	1	4	CB1G	AB2	
GUYS & CONNECTIONS INCLUDED	3/16EHS	1/4EHS	BG2142	BG2144	5/16THH	3/8THH	1/2TBE&J
	1625'	700'	18	6	18	6	12
ANCHORS & GROUNDING INCLUDED	GAC3455TOP	AGK1GGX	BGK3GGX	CPC.5/.75	3/4x12PP	TBSAFETY	
	3	1	3	3	1	3	

180' ROHN 45G
All parts shown in table are included when ordering
Part No: 45G90R180



STANDARD DESIGN - 45G
90MPH REV. G, 70MPH REV. F

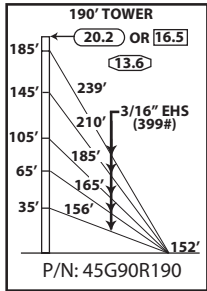

TOWER PARTS INCLUDED	45G	45AG2	BPC45G	GA45GD	FDNS	
					BASE	ANCHOR
	18	1	1	5	CB1G	AB2
GUYS & CONNECTIONS INCLUDED	3/16EHS	BG2142	5/16THH	1/2TBE&J	TBSAFETY	
	3050'	30	30	15	3	
ANCHORS & GROUNDING INCLUDED	GAC3455TOP	AGK1GGX	BGK3GGX	CPC.5/.75	3/4x12PP	
	3	1	3	3	1	

190' ROHN 45G
All parts shown in table are included when ordering
Part No: 45G90R190

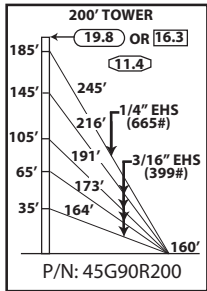

TOWER PARTS INCLUDED	45G	BPC45G	APL45G	GA45GD	FDNS		
					BASE	ANCHOR	
	20	1	1	5	CB1G	AB2	
GUYS & CONNECTIONS INCLUDED	3/16EHS	1/4EHS	BG2142	BG2144	5/16THH	3/8THH	1/2TBE&J
	2375'	800'	24	6	24	6	15
ANCHORS & GROUNDING INCLUDED	GAC3455TOP	AGK1GGX	BGK3GGX	CPC.5/.75	3/4x12PP	TBSAFETY	
	3	1	3	3	1	3	

200' ROHN 45G
All parts shown in table are included when ordering
Part No: 45G90R200

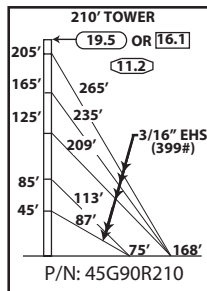

TOWER PARTS INCLUDED	45G	APL45G	BPC45G	GA45GD	BASE	INNER ANCHOR	OUTER ANCHOR
					21	1	1
GUYS & CONNECTIONS INCLUDED	3/16EHS	BG2142	5/16THH	1/2TBE&J	TBSAFETY		
	2900'	30	30	15	6		
ANCHORS & GROUNDING INCLUDED	GAC3455TOP	AGK1GGX	BGK3GGX	CPC.5/.75	3/4x12PP		
	6	2	3	6	1		

210' ROHN 45G
All parts shown in table are included when ordering
Part No: 45G90R210

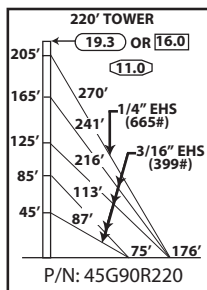

TOWER PARTS INCLUDED	45G	BPC45G	APL45G	GA45GD	BASE	INNER ANCHOR	OUTER ANCHOR
					22	1	1
GUYS & CONNECTIONS INCLUDED	3/16EHS	1/4EHS	BG2142	BG2144	5/16THH	3/8THH	1/2TBE&J
	2100'	875'	24	6	24	6	15
ANCHORS & GROUNDING INCLUDED	GAC3455TOP	AGK1GGX	BGK3GGX	CPC.5/.75	3/4x12PP	TBSAFETY	
	6	2	3	6	1	6	

220' ROHN 45G
All parts shown in table are included when ordering
Part No: 45G90R220

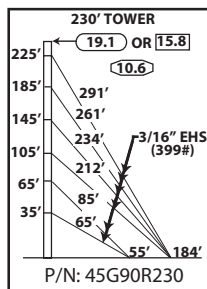

TOWER PARTS INCLUDED	45G	APL45G	BPC45G	GA45GD	BASE	INNER ANCHOR	OUTER ANCHOR
					23	1	1
GUYS & CONNECTIONS INCLUDED	3/16EHS	BG2142	5/16THH	1/2TBE&J	TBSAFETY		
	3675'	36	36	18	6		
ANCHORS & GROUNDING INCLUDED	GAC3455TOP	AGK1GGX	BGK3GGX	CPC.5/.75	3/4x12PP		
	6	2	3	6	1		

230' ROHN 45G
All parts shown in table are included when ordering
Part No: 45G90R230



STANDARD DESIGN - 45G
90MPH REV. G, 70MPH REV. F

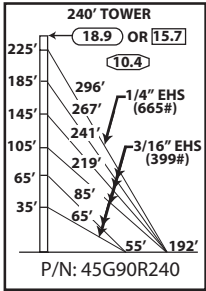

TOWER PARTS INCLUDED	45G	BPC45G	APL45G	GA45GD	BASE	INNER ANCHOR	OUTER ANCHOR
	24	1	1	6	CB2G	AB1	AB2
GUYS & CONNECTIONS INCLUDED	3/16EHS	1/4EHS	BG2142	BG2144	5/16THH	3/8THH	1/2TBE&J
	2800'	950'	30	6	30	6	18
ANCHORS & GROUNDING INCLUDED	GAC3455TOP	AGK1GGX	BGK3GGX	CPC.5/.75	3/4x12PP	TBSAFETY	
	6	2	3	6	1	6	

240' ROHN 45G
All parts shown in table are included when ordering
Part No: 45G90R240

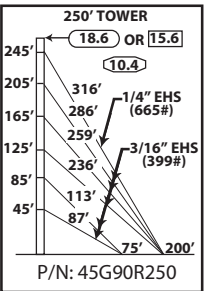

TOWER PARTS INCLUDED	45G	BPC45G	APL45G	GA45GD	BASE	INNER ANCHOR	OUTER ANCHOR
	25	1	1	6	CB2G	AB1	AB2
GUYS & CONNECTIONS INCLUDED	3/16EHS	1/4EHS	BG2142	BG2144	5/16THH	3/8THH	1/2TBE&J
	3125'	1025'	30	6	30	6	18
ANCHORS & GROUNDING INCLUDED	GAC3455TOP	AGK1GGX	BGK3GGX	CPC.5/.75	3/4x12PP	TBSAFETY	
	6	2	3	6	1	6	

250' ROHN 45G
All parts shown in table are included when ordering
Part No: 45G90R250

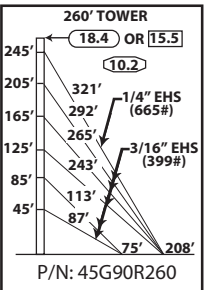

TOWER PARTS INCLUDED	45G	BPC45G	APL45G	GA45GD	BASE	INNER ANCHOR	OUTER ANCHOR
	26	1	1	6	CB3G	AB2	AB2
GUYS & CONNECTIONS INCLUDED	3/16EHS	1/4EHS	BG2142	BG2144	5/16THH	3/8THH	1/2TBE&J
	3200'	1025'	30	6	30	6	18
ANCHORS & GROUNDING INCLUDED	GAC3455TOP	AGK1GGX	BGK3GGX	CPC.5/.75	3/4x12PP	TBSAFETY	
	6	2	3	6	1	6	

260' ROHN 45G
All parts shown in table are included when ordering
Part No: 45G90R260

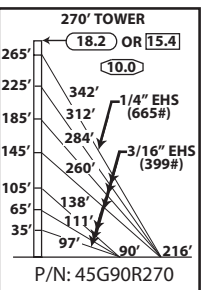

TOWER PARTS INCLUDED	45G	BPC45G	APL45G	GA45GD	BASE	INNER ANCHOR	OUTER ANCHOR
	27	1	1	7	CB3G	AB2	AB2
GUYS & CONNECTIONS INCLUDED	3/16EHS	1/4EHS	BG2142	BG2144	5/16THH	3/8THH	1/2TBE&J
	3825'	1100'	36	6	36	6	21
ANCHORS & GROUNDING INCLUDED	GAC3455TOP	AGK1GGX	BGK3GGX	CPC.5/.75	3/4x12PP	TBSAFETY	
	6	2	3	6	1	6	

270' ROHN 45G
All parts shown in table are included when ordering
Part No: 45G90R270

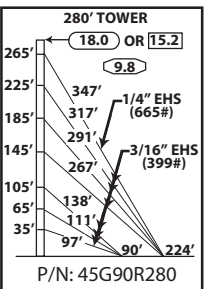

TOWER PARTS INCLUDED	45G	BPC45G	APL45G	GA45GD	BASE	INNER ANCHOR	OUTER ANCHOR
	28	1	1	7	CB3G	AB2	AB2
GUYS & CONNECTIONS INCLUDED	3/16EHS	1/4EHS	BG2142	BG2144	5/16THH	3/8THH	1/2TBE&J
	3900'	1125'	36	6	36	6	21
ANCHORS & GROUNDING INCLUDED	GAC3455TOP	AGK1GGX	BGK3GGX	CPC.5/.75	3/4x12PP	TBSAFETY	
	6	2	3	6	1	6	

280' ROHN 45G
All parts shown in table are included when ordering
Part No: 45G90R280



STANDARD DESIGN - 45G

90MPH REV. G, 70MPH REV. F

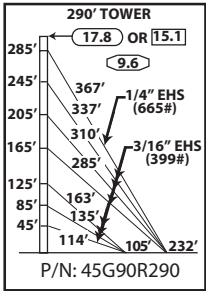

TOWER PARTS INCLUDED	45G	BPC45G	APL45G	GA45GD	BASE	INNER ANCHOR	OUTER ANCHOR
		29	1	1	7	CB3G	AB2
GUYS & CONNECTIONS INCLUDED	3/16EHS	1/4EHS	BG2142	BG2144	5/16THH	3/8THH	1/2TBE&J
	4275'	1175'	36	6	36	6	21
ANCHORS & GROUNDING INCLUDED	GAC3455TOP	AGK1GGX	BGK3GGX	CPC.5/.75	3/4x12PP	TBSAFETY	
	6	2	3	6	1	6	

290' ROHN 45G
 All parts shown in table are included when ordering
 Part No: 45G90R290

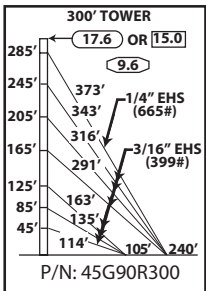

TOWER PARTS INCLUDED	45G	BPC45G	APL45G	GA45GD	BASE	INNER ANCHOR	OUTER ANCHOR
		30	1	1	7	CB3G	AB2
GUYS & CONNECTIONS INCLUDED	3/16EHS	1/4EHS	BG2142	BG2144	5/16THH	3/8THH	1/2TBE&J
	4350'	1200'	36	6	36	6	21
ANCHORS & GROUNDING INCLUDED	GAC3455TOP	AGK1GGX	BGK3GGX	CPC.5/.75	3/4x12PP	TBSAFETY	
	6	2	3	6	1	6	

300' ROHN 45G
 All parts shown in table are included when ordering
 Part No: 45G90R300



STANDARD DESIGN - 45G 110MPH REV. G, 90MPH REV. F

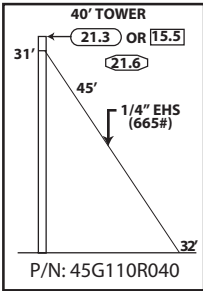

TOWER PARTS INCLUDED	45G	45AG2	BPC45G	GA45GD	FDNS	
					BASE	ANCHOR
	3	1	1	1	CB1G	AB2
GUYS & CONNECTIONS INCLUDED	1/4EHS	BG2144	3/8THH	1/2TBE&J	TBSAFETY	
	150'	6	6	3	3	
ANCHORS & GROUNDING INCLUDED	GAC3455TOP	AGK1GGX	BGK3GGX	CPC.5/.75	3/4x12PP	
	3	1	3	3	1	

40' ROHN 45G
All parts shown in table are included when ordering
Part No: 45G110R040

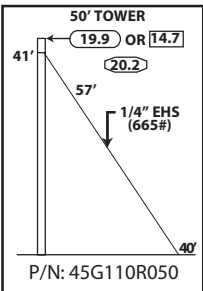

TOWER PARTS INCLUDED	45G	45AG2	BPC45G	GA45GD	FDNS	
					BASE	ANCHOR
	4	1	1	1	CB1G	AB2
GUYS & CONNECTIONS INCLUDED	1/4EHS	BG2144	3/8THH	1/2TBE&J	TBSAFETY	
	200'	6	6	3	3	
ANCHORS & GROUNDING INCLUDED	GAC3455TOP	AGK1GGX	BGK3GGX	CPC.5/.75	3/4x12PP	
	3	1	3	3	1	

50' ROHN 45G
All parts shown in table are included when ordering
Part No: 45G110R050

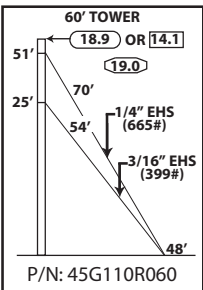

TOWER PARTS INCLUDED	45G	45AG2	BPC45G	GA45GD	FDNS		
					BASE	ANCHOR	
	5	1	1	2	CB1G	AB2	
GUYS & CONNECTIONS INCLUDED	3/16EHS	1/4EHS	BG2142	BG2144	5/16THH	3/8THH	1/2TBE&J
	175'	225'	6	6	6	6	6
ANCHORS & GROUNDING INCLUDED	GAC3455TOP	AGK1GGX	BGK3GGX	CPC.5/.75	3/4x12PP	TBSAFETY	
	3	1	3	3	1	3	

60' ROHN 45G
All parts shown in table are included when ordering
Part No: 45G110R060

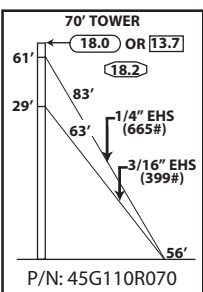

TOWER PARTS INCLUDED	45G	45AG2	BPC45G	GA45GD	FDNS		
					BASE	ANCHOR	
	6	1	1	2	CB1G	AB2	
GUYS & CONNECTIONS INCLUDED	3/16EHS	1/4EHS	BG2142	BG2144	5/16THH	3/8THH	1/2TBE&J
	225'	275'	6	6	6	6	6
ANCHORS & GROUNDING INCLUDED	GAC3455TOP	AGK1GGX	BGK3GGX	CPC.5/.75	3/4x12PP	TBSAFETY	
	3	1	3	3	1	3	

70' ROHN 45G
All parts shown in table are included when ordering
Part No: 45G110R070

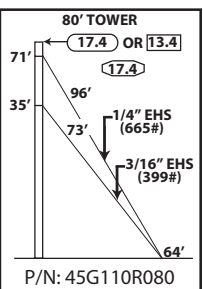

TOWER PARTS INCLUDED	45G	45AG2	BPC45G	GA45GD	FDNS		
					BASE	ANCHOR	
	7	1	1	2	CB1G	AB2	
GUYS & CONNECTIONS INCLUDED	3/16EHS	1/4EHS	BG2142	BG2144	5/16THH	3/8THH	1/2TBE&J
	250'	325'	6	6	6	6	6
ANCHORS & GROUNDING INCLUDED	GAC3455TOP	AGK1GGX	BGK3GGX	CPC.5/.75	3/4x12PP	TBSAFETY	
	3	1	3	3	1	3	

80' ROHN 45G
All parts shown in table are included when ordering
Part No: 45G110R080



STANDARD DESIGN - 45G
110MPH REV. G, 90MPH REV. F

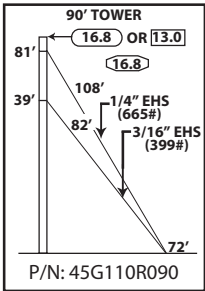

TOWER PARTS INCLUDED	45G	45AG2	BPC45G	GA45GD	FDNS		
					BASE	ANCHOR	
	8	1	1	2	CB1G	AB2	
GUYS & CONNECTIONS INCLUDED	3/16EHS	1/4EHS	BG2142	BG2144	5/16THH	3/8THH	1/2TBE&J
	275'	350'	6	6	6	6	6
ANCHORS & GROUNDING INCLUDED	GAC3455TOP	AGK1GGX	BGK3GGX	CPC.5/.75	3/4x12PP	TBSAFETY	
	3	1	3	3	1	3	

90' ROHN 45G
All parts shown in table are included when ordering
Part No: 45G110R090

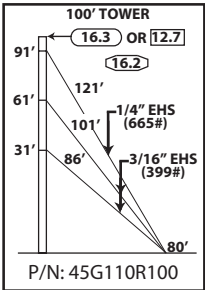

TOWER PARTS INCLUDED	45G	45AG2	BPC45G	GA45GD	FDNS		
					BASE	ANCHOR	
	9	1	1	3	CB1G	AB2	
GUYS & CONNECTIONS INCLUDED	3/16EHS	1/4EHS	BG2142	BG2144	5/16THH	3/8THH	1/2TBE&J
	600'	400'	12	6	12	6	9
ANCHORS & GROUNDING INCLUDED	GAC3455TOP	AGK1GGX	BGK3GGX	CPC.5/.75	3/4x12PP	TBSAFETY	
	3	1	3	3	1	3	

100' ROHN 45G
All parts shown in table are included when ordering
Part No: 45G110R100

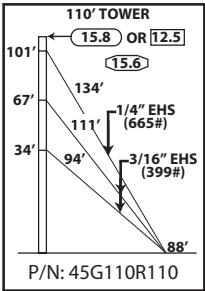

TOWER PARTS INCLUDED	45G	45AG2	BPC45G	GA45GD	FDNS		
					BASE	ANCHOR	
	10	1	1	3	CB1G	AB2	
GUYS & CONNECTIONS INCLUDED	3/16EHS	1/4EHS	BG2142	BG2144	5/16THH	3/8THH	1/2TBE&J
	675'	450'	12	6	12	6	9
ANCHORS & GROUNDING INCLUDED	GAC3455TOP	AGK1GGX	BGK3GGX	CPC.5/.75	3/4x12PP	TBSAFETY	
	3	1	3	3	1	3	

110' ROHN 45G
All parts shown in table are included when ordering
Part No: 45G110R110

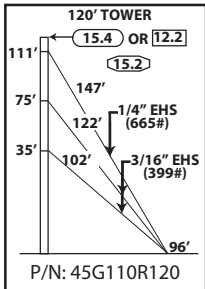

TOWER PARTS INCLUDED	45G	45AG2	BPC45G	GA45GD	FDNS		
					BASE	ANCHOR	
	11	1	1	3	CB1G	AB2	
GUYS & CONNECTIONS INCLUDED	3/16EHS	1/4EHS	BG2142	BG2144	5/16THH	3/8THH	1/2TBE&J
	725'	475'	12	6	12	6	9
ANCHORS & GROUNDING INCLUDED	GAC3455TOP	AGK1GGX	BGK3GGX	CPC.5/.75	3/4x12PP	TBSAFETY	
	3	1	3	3	1	3	

120' ROHN 45G
All parts shown in table are included when ordering
Part No: 45G110R120

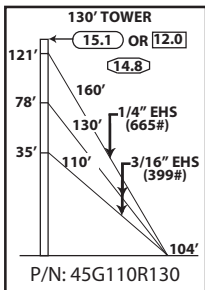

TOWER PARTS INCLUDED	45G	45AG2	BPC45G	GA45GD	FDNS		
					BASE	ANCHOR	
	12	1	1	3	CB1G	AB2	
GUYS & CONNECTIONS INCLUDED	3/16EHS	1/4EHS	BG2142	BG2144	5/16THH	3/8THH	1/2TBE&J
	775'	525'	12	6	12	6	9
ANCHORS & GROUNDING INCLUDED	GAC3455TOP	AGK1GGX	BGK3GGX	CPC.5/.75	3/4x12PP	TBSAFETY	
	3	1	3	3	1	3	

130' ROHN 45G
All parts shown in table are included when ordering
Part No: 45G110R130



STANDARD DESIGN - 45G

110MPH REV. G, 90MPH REV. F

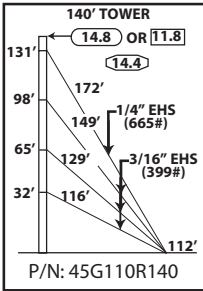

TOWER PARTS INCLUDED	45G	45AG2	BPC45G	GA45GD	FDNS		
					BASE	ANCHOR	
	13	1	1	4	CB1G	AB2	
GUYS & CONNECTIONS INCLUDED	3/16EHS	1/4EHS	BG2142	BG2144	5/16THH	3/8THH	1/2TBE&J
	1275'	550'	18	6	18	6	12
ANCHORS & GROUNDING INCLUDED	GAC3455TOP	AGK1GGX	BGK3GGX	CPC.5/.75	3/4x12PP	TBSAFETY	
	3	1	3	3	1	3	

140' ROHN 45G
All parts shown in table are included when ordering
Part No: 45G110R140

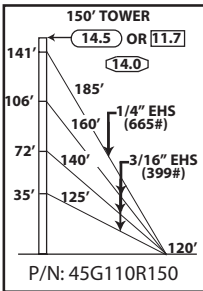

TOWER PARTS INCLUDED	45G	45AG2	BPC45G	GA45GD	FDNS		
					BASE	ANCHOR	
	14	1	1	4	CB1G	AB2	
GUYS & CONNECTIONS INCLUDED	3/16EHS	1/4EHS	BG2142	BG2144	5/16THH	3/8THH	1/2TBE&J
	1375'	600'	18	6	18	6	12
ANCHORS & GROUNDING INCLUDED	GAC3455TOP	AGK1GGX	BGK3GGX	CPC.5/.75	3/4x12PP	TBSAFETY	
	3	1	3	3	1	3	

150' ROHN 45G
All parts shown in table are included when ordering
Part No: 45G110R150

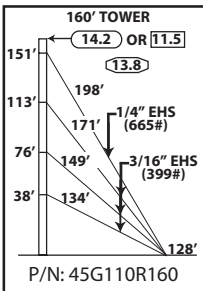

TOWER PARTS INCLUDED	45G	45AG2	BPC45G	GA45GD	FDNS		
					BASE	ANCHOR	
	15	1	1	4	CB2G	AB2	
GUYS & CONNECTIONS INCLUDED	3/16EHS	1/4EHS	BG2142	BG2144	5/16THH	3/8THH	1/2TBE&J
	1450'	650'	18	6	18	6	12
ANCHORS & GROUNDING INCLUDED	GAC3455TOP	AGK1GGX	BGK3GGX	CPC.5/.75	3/4x12PP	TBSAFETY	
	3	1	3	3	1	3	

160' ROHN 45G
All parts shown in table are included when ordering
Part No: 45G110R160

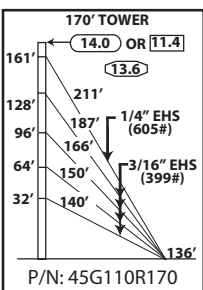

TOWER PARTS INCLUDED	45G	45AG2	BPC45G	GA45GD	FDNS		
					BASE	ANCHOR	
	16	1	1	5	CB2G	AB3	
GUYS & CONNECTIONS INCLUDED	3/16EHS	1/4EHS	BG2142	BG2144	5/16THH	3/8THH	5/8TBE&J
	2050'	675'	24	6	24	6	15
ANCHORS & GROUNDING INCLUDED	GAC5655TOP	AGK1GGX	BGK3GGX	CPC1/1.25	3/4x12PP	TBSAFETY	
	3	1	3	3	1	3	

170' ROHN 45G
All parts shown in table are included when ordering
Part No: 45G110R170

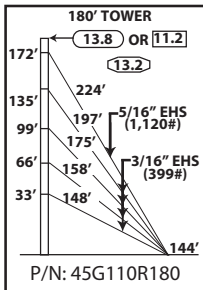

TOWER PARTS INCLUDED	45G	45GL2*	BPC45G	GA45GD	APL45G	FDNS	
						BASE	ANCHOR
	17	1	1	5	1	CB2G	AB3
GUYS & CONNECTIONS INCLUDED	3/16EHS	142265	BG2142	BG2146	5/16THH	7/16THH	5/8TBE&J
	2175'	725'	24	6	24	6	15
ANCHORS & GROUNDING INCLUDED	GAC5655TOP	AGK1GGX	BGK3GGX	CPC1/1.25	3/4x12PP	TBSAFETY	
	3	1	3	3	1	3	

180' ROHN 45G
All parts shown in table are included when ordering
Part No: 45G110R180

* 45GL2 Lug section required for 5/16" guy



STANDARD DESIGN - 45G
110MPH REV. G, 90MPH REV. F

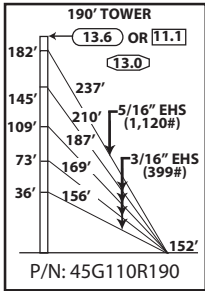

TOWER PARTS INCLUDED	45G	45GL2*	BPC45G	GA45GD	APL45G	FDNS	
	18	1	1	5	1	BASE CB2G	ANCHOR AB3
GUYS & CONNECTIONS INCLUDED	3/16EHS	142265	BG2142	BG2146	5/16THH	7/16THH	5/8TBE&J
	2300'	725'	24	6	24	6	15
ANCHORS & GROUNDING INCLUDED	GAC5655TOP	AGK1GGX	BGK3GGX	CPC1/1.25	3/4x12PP	TBSAFETY	
	3	1	3	3	1	3	

190' ROHN 45G
All parts shown in table are included when ordering
Part No: 45G110R190

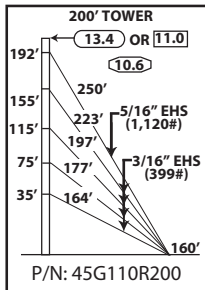

TOWER PARTS INCLUDED	45G	45GL2*	BPC45G	GA45GD	APL45G	FDNS	
	19	1	1	5	1	BASE CB2G	ANCHOR AB3
GUYS & CONNECTIONS INCLUDED	3/16EHS	142265	BG2142	BG2146	5/16THH	7/16THH	5/8TBE&J
	2425'	800'	24	6	24	6	15
ANCHORS & GROUNDING INCLUDED	GAC5655TOP	AGK1GGX	BGK3GGX	CPC1/1.25	3/4x12PP	TBSAFETY	
	3	1	3	3	1	3	

200' ROHN 45G
All parts shown in table are included when ordering
Part No: 45G110R200

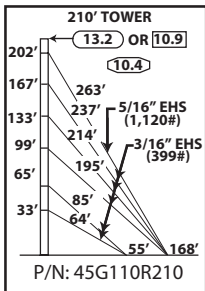

TOWER PARTS INCLUDED	45G	BPC45G	45GL2*	APL45G	GA45GD	BASE	INNER ANCHOR	OUTER ANCHOR
	20	1	1	1	6	CB3G	AB2	AB3
GUYS & CONNECTIONS INCLUDED	3/16EHS	142265	BG2142	BG2146	5/16THH			
	2550'	850'	30	6	30			
	7/16THH	1/2TBE&J	5/8TBE&J	TBSAFETY	3/4x12PP			
	6	6	12	6	1			
ANCHORS & GROUNDING INCLUDED	GAC5655TOP	GAC3455TOP	AGK1GGX	BGK3GGX	CPC.5/1.75	CPC1/1.25		
	3	3	2	3	3	3		

210' ROHN 45G
All parts shown in table are included when ordering
Part No: 45G110R210

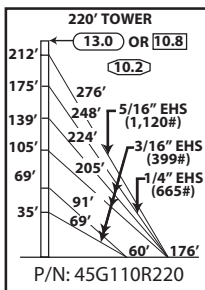

TOWER PARTS INCLUDED	45G	BPC45G	45GL2*	APL45G	GA45GD	BASE	INNER ANCHOR	OUTER ANCHOR	
	21	1	1	1	6	CB3G	AB2	AB3	
GUYS & CONNECTIONS INCLUDED	3/16EHS	1/4EHS	142265	BG2142	BG2144	BG2146			
	1875'	800'	900'	24	6	6			
	5/16THH	3/8THH	7/16THH	1/2TBE&J	5/8TBE&J	TBSAFETY			
	24	6	6	6	12	6			
ANCHORS & GROUNDING INCLUDED	GAC5655TOP	GAC3455TOP	AGK1GGX	BGK3GGX	CPC.5/1.75	CPC1/1.25	3/4X12PP		
	3	3	2	3	3	3	1		

220' ROHN 45G
All parts shown in table are included when ordering
Part No: 45G110R220

* 45GL2 Lug section required for 5/16" guy



STANDARD DESIGN - 45G

110MPH REV. G, 90MPH REV. F

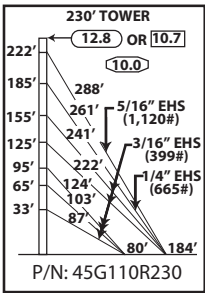

TOWER PARTS INCLUDED	45G	BPC45G	APL45G	GA45GD	45GL2*	BASE	INNER ANCHOR	OUTER ANCHOR
		22	1	1	7	1	CB3G	AB2
GUYS & CONNECTIONS INCLUDED	3/16EHS	1/4EHS	142265	BG2142	BG2144	BG2146		
	2475'	850'	925'	30	6	6		
	5/16THH	3/8THH	7/16THH	1/2TBE&J	5/8TBE&J	TBSAFETY		
	30	6	6	9	12	6		
ANCHORS & GROUNDING INCLUDED	GAC3455TOP	GAC5655TOP	AGK1GGX	BGK3GGX	CPC.5/.75	CPC1/1.25	3/4x12PP	
	3	3	2	3	3	3	1	

230' ROHN 45G
All parts shown in table are included when ordering
Part No: 45G110R230

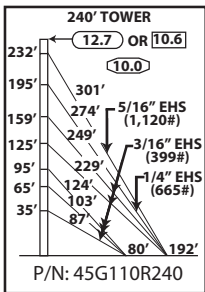

TOWER PARTS INCLUDED	45G	BPC45G	APL45G	GA45GD	45GL2*	BASE	INNER ANCHOR	OUTER ANCHOR
		23	1	1	7	1	CB3G	AB2
GUYS & CONNECTIONS INCLUDED	3/16EHS	1/4EHS	142265	BG2142	BG2144	BG2146		
	2525'	875'	975'	30	6	6		
	5/16THH	3/8THH	7/16THH	1/2TBE&J	5/8TBE&J	TBSAFETY		
	30	6	6	9	12	6		
ANCHORS & GROUNDING INCLUDED	GAC3455TOP	GAC5655TOP	AGK1GGX	BGK3GGX	CPC.5/.75	CPC1/1.25	3/4x12PP	
	3	3	2	3	3	3	1	

240' ROHN 45G
All parts shown in table are included when ordering
Part No: 45G110R240

* 45GL2 Lug section required for 5/16" guy



STANDARD DESIGN - 45G
130MPH REV. G, 110MPH REV. F

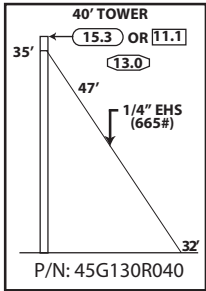

TOWER PARTS INCLUDED	45G	45AG2	BPC45G	GA45GD	FDNS	
					BASE	ANCHOR
	3	1	1	1	CB1G	AB2
GUYS & CONNECTIONS INCLUDED	1/4EHS	BG2144	3/8THH	1/2TBE&J	TBSAFETY	
	150'	6	6	3	3	
ANCHORS & GROUNDING INCLUDED	GAC3455TOP	AGK1GGX	BGK3GGX	CPC.5/.75	3/4x12PP	
	3	1	3	3	1	

40' ROHN 45G
All parts shown in table are included when ordering
Part No: 45G130R040

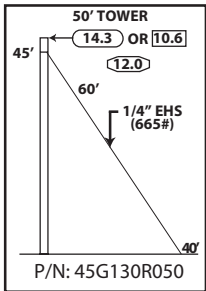

TOWER PARTS INCLUDED	45G	45AG2	BPC45G	GA45GD	FDNS	
					BASE	ANCHOR
	4	1	1	1	CB1G	AB2
GUYS & CONNECTIONS INCLUDED	1/4EHS	BG2144	3/8THH	1/2TBE&J	TBSAFETY	
	200'	6	6	3	3	
ANCHORS & GROUNDING INCLUDED	GAC3455TOP	AGK1GGX	BGK3GGX	CPC.5/.75	3/4x12PP	
	3	1	3	3	1	

50' ROHN 45G
All parts shown in table are included when ordering
Part No: 45G130R050

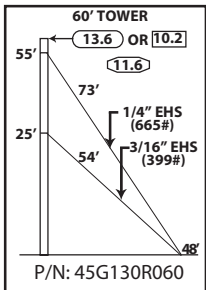

TOWER PARTS INCLUDED	45G	45AG2	BPC45G	GA45GD	FDNS		
					BASE	ANCHOR	
	5	1	1	2	CB1G	AB2	
GUYS & CONNECTIONS INCLUDED	3/16EHS	1/4EHS	BG2142	BG2144	5/16THH	3/8THH	1/2TBE&J
	175'	250'	6	6	6	6	6
ANCHORS & GROUNDING INCLUDED	GAC3455TOP	AGK1GGX	BGK3GGX	CPC.5/.75	3/4x12PP	TBSAFETY	
	3	1	3	3	1	3	

60' ROHN 45G
All parts shown in table are included when ordering
Part No: 45G130R060

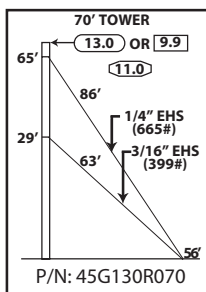

TOWER PARTS INCLUDED	45G	45AG2	BPC45G	GA45GD	FDNS		
					BASE	ANCHOR	
	6	1	1	2	CB1G	AB2	
GUYS & CONNECTIONS INCLUDED	3/16EHS	1/4EHS	BG2142	BG2144	5/16THH	3/8THH	1/2TBE&J
	225'	275'	6	6	6	6	6
ANCHORS & GROUNDING INCLUDED	GAC3455TOP	AGK1GGX	BGK3GGX	CPC.5/.75	3/4x12PP	TBSAFETY	
	3	1	3	3	1	3	

70' ROHN 45G
All parts shown in table are included when ordering
Part No: 45G130R070

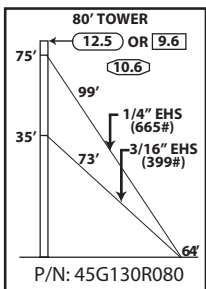

TOWER PARTS INCLUDED	45G	45AG2	BPC45G	GA45GD	FDNS		
					BASE	ANCHOR	
	7	1	1	2	CB1G	AB2	
GUYS & CONNECTIONS INCLUDED	3/16EHS	1/4EHS	BG2142	BG2144	5/16THH	3/8THH	1/2TBE&J
	250'	325'	6	6	6	6	6
ANCHORS & GROUNDING INCLUDED	GAC3455TOP	AGK1GGX	BGK3GGX	CPC.5/.75	3/4x12PP	TBSAFETY	
	3	1	3	3	1	3	

80' ROHN 45G
All parts shown in table are included when ordering
Part No: 45G130R080





STANDARD DESIGN - 45G
130MPH REV. G, 110MPH REV. F

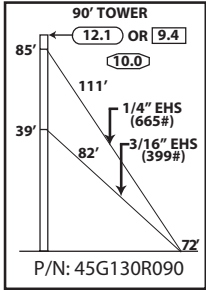

TOWER PARTS INCLUDED	45G	45AG2	BPC45G	GA45GD	FDNS		
	8	1	1	2	BASE CB1G	ANCHOR AB2	
GUYS & CONNECTIONS INCLUDED	3/16EHS	1/4EHS	BG2142	BG2144	5/16THH	3/8THH	1/2TBE&J
	275'	375'	6	6	6	6	6
ANCHORS & GROUNDING INCLUDED	GAC3455TOP	AGK1GGX	BGK3GGX	CPC.5/.75	3/4x12PP	TBSAFETY	
	3	1	3	3	1	3	

90' ROHN 45G
All parts shown in table are included when ordering
Part No: 45G130R090

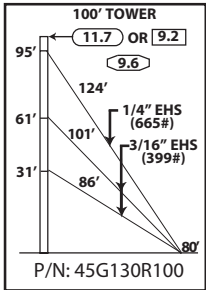

TOWER PARTS INCLUDED	45G	45AG2	BPC45G	GA45GD	FDNS		
	9	1	1	3	BASE CB1G	ANCHOR AB2	
GUYS & CONNECTIONS INCLUDED	3/16EHS	1/4EHS	BG2142	BG2144	5/16THH	3/8THH	1/2TBE&J
	600'	400'	12	6	12	6	9
ANCHORS & GROUNDING INCLUDED	GAC3455TOP	AGK1GGX	BGK3GGX	CPC.5/.75	3/4x12PP	TBSAFETY	
	3	1	3	3	1	3	

100' ROHN 45G
All parts shown in table are included when ordering
Part No: 45G130R100

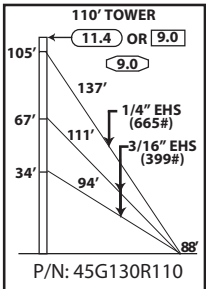

TOWER PARTS INCLUDED	45G	45AG2	BPC45G	GA45GD	FDNS		
	10	1	1	3	BASE CB1G	ANCHOR AB2	
GUYS & CONNECTIONS INCLUDED	3/16EHS	1/4EHS	BG2142	BG2144	5/16THH	3/8THH	1/2TBE&J
	675'	450'	12	6	12	6	9
ANCHORS & GROUNDING INCLUDED	GAC3455TOP	AGK1GGX	BGK3GGX	CPC.5/.75	3/4x12PP	TBSAFETY	
	3	1	3	3	1	3	

110' ROHN 45G
All parts shown in table are included when ordering
Part No: 45G130R110

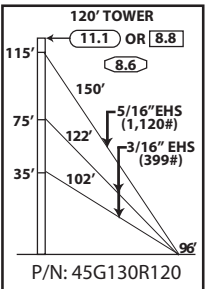

TOWER PARTS INCLUDED	45G	45GL5*	BPC45G	GA45GD	APL45G	FDNS	
	11	1	1	3	1	BASE CB1G	ANCHOR AB2
GUYS & CONNECTIONS INCLUDED	3/16EHS	142265	BG2142	BG2146	5/16THH	7/16THH	1/2TBE&J
	725'	500'	12	6	12	6	6
ANCHORS & GROUNDING INCLUDED	GAC3455TOP	AGK1GGX	BGK3GGX	CPC.5/.75	3/4x12PP	TBSAFETY	
	3	1	3	3	1	3	

120' ROHN 45G
All parts shown in table are included when ordering
Part No: 45G130R120

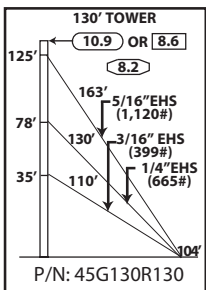

TOWER PARTS INCLUDED	45G	45GL5*	BPC45G	GA45GD	APL45G	FDNS	
	12	1	1	3	1	BASE CB2G	ANCHOR AB3
GUYS & CONNECTIONS INCLUDED	3/16EHS	1/4EHS	142265	BG2142	BG2144	BG2146	
	350'	425'	525'	6	6	6	
	5/16THH	3/8THH	7/16THH	5/8TBE&J	TBSAFETY		
ANCHORS & GROUNDING INCLUDED	GAC5655TOP	AGK1GGX	BGK3GGX	CPC1/1.25	3/4x12PP		
	3	1	3	3	1		

130' ROHN 45G
All parts shown in table are included when ordering
Part No: 45G130R130

* 45GL5 Lug section required for 5/16" guy





STANDARD DESIGN - 45G
130MPH REV. G, 110MPH REV. F

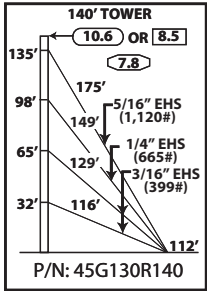

TOWER PARTS INCLUDED	45G	45GL5*	BPC45G	GA45GD	APL45G	FDNS	
						BASE	ANCHOR
	13	1	1	4	1	CB2G	AB3
GUYS & CONNECTIONS INCLUDED	3/16EHS	1/4EHS	142265	BG2142	BG2144	BG2146	
	800'	475'	575'	12	6	6	
	5/16THH	3/8THH	7/16THH	5/8TBE&J	TBSAFETY		
	12	6	6	12	3		
ANCHORS & GROUNDING INCLUDED	GAC5655TOP	AGK1GGX	BGK3GGX	CPC1/1.25	3/4x12PP		
	3	1	3	3	1		

140' ROHN 45G
All parts shown in table are included when ordering
Part No: 45G130R140

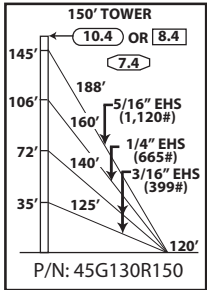

TOWER PARTS INCLUDED	45G	45GL5*	BPC45G	GA45GD	APL45G	FDNS	
						BASE	ANCHOR
	14	1	1	4	1	CB2G	AB3
GUYS & CONNECTIONS INCLUDED	3/16EHS	1/4EHS	142265	BG2142	BG2144	BG2146	
	850'	525'	600'	12	6	6	
	5/16THH	3/8THH	7/16THH	5/8TBE&J	TBSAFETY		
	12	6	6	12	3		
ANCHORS & GROUNDING INCLUDED	GAC5655TOP	AGK1GGX	BGK3GGX	CPC1/1.25	3/4x12PP		
	3	1	3	3	1		

150' ROHN 45G
All parts shown in table are included when ordering
Part No: 45G130R150

* 45GL5 Lug section required for 5/16" guy



PARTS & ACCESSORIES

<p>TOP SECTION 45AG</p>	<p>TOP SECTION 45AG1</p>	<p>TOP SECTION 45AG2</p>	<p>TOP SECTION 45AG3</p>
------------------------------------	-------------------------------------	-------------------------------------	-------------------------------------

<p>TOP SECTION 45AG4 TOP PLATE HOLE PATTERN IS THE SAME AS BPL45G.</p>	<p>TOP SECTION 45AG5</p>	<p>BEARING PLATE BPL45G CONVERTS STANDARD SECTION TO A TOP SECTION. HOLE PATTERN FITS TB3 (2" O.D.) AND TB4 (3" O.D.) THRUST BEARINGS.</p>	<p>TOP PLATE APL45G FOR MOUNTING BEACON OR LIGHTNING ROD.</p>
---	-------------------------------------	---	--

<p>TOP MOUNT 45TDMKD - NO MAST 45TDM2S3KD - 2 3/8" O.D. MAST 45TDM2S53KD - 2 7/8" O.D. MAST 45TDM3S3KD - 3 1/2" O.D. MAST 45TDM3S53KD - 4" O.D. MAST 45TDM4S3KD - 4 1/2" O.D. MAST MOUNTING TUBE PROVIDED IS 7' LONG.</p>	<p>ACCESSORY SHELF AS455G FOR MOUNTING MANY POPULAR ROTORS. FIELD DRILLING MAY BE NECESSARY FOR SOME ROTORS.</p>	<p>LIGHTNING ROD LRCL 5' COPPER CLAD MOUNTS TO APL45G.</p>
--	---	---



PARTS & ACCESSORIES

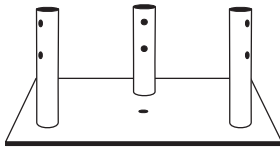

CONCRETE BASE PLATE
BPC45G*

FOR USE WITH 3/4X12PP PIER PIN
EMBEDDED IN CONCRETE.

CONCRETE BASE PLATE IS TO BE
USED FOR BRACKETED AND
GUYED APPLICATIONS ONLY.



PIER PIN
3/4X12PP

FOR USE WITH BPC45G
EMBEDDED IN CONCRETE.

PIER PIN MUST BE ORDERED
SEPARATELY, UNLESS BEING
PURCHASED AS PART OF
A COMPLETE TOWER KIT.

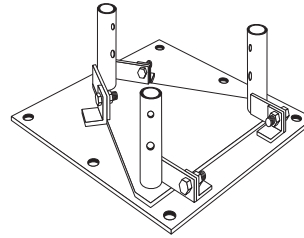

HINGED BASE PLATE
BPH45G*

FOR USE WITH 5/8X12BB BASE BOLTS
(ORDERED SEPARATELY).
HINGED TO ALLOW TOWER TO
BE ROTATED UP FROM BASE
DURING INSTALLATION.

HINGED BASE PLATE IS TO BE
USED FOR BRACKETED AND GUYED
APPLICATIONS ONLY.

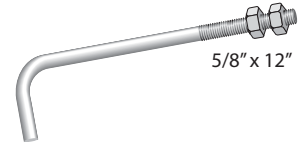

BASE BOLT
5/8X12BB

FOR USE WITH BPH45G

(6) REQUIRED, ORDERED SEPARATELY.



TAPERED BASE
45TG*

CAN BE USED WITH A4197L
BASE INSULATOR OR WITH
3/4X12PP, ORDERED SEPARATELY.

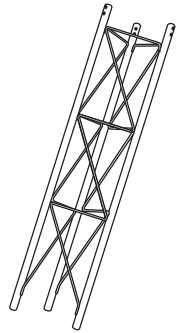

5' SHORT BASE
SB45G

FOR EMBEDMENT IN CONCRETE.

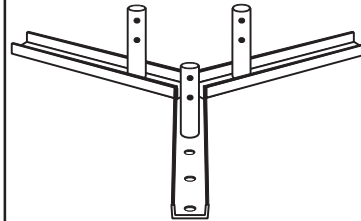

FLAT ROOF MOUNT
FR45G*

BOLTS DIRECTLY TO FLAT ROOF SURFACE.

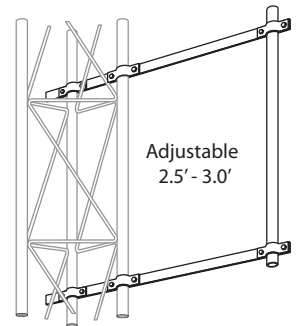

SIDE ARM BRACKET
SA253UA

MOUNTING TUBE PROVIDED IS 3' LONG,
2 - 1/4" O.D.

Adjustable
2.5' - 3.0'

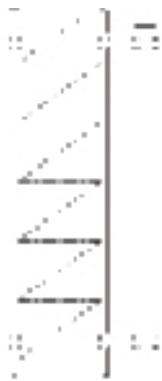

DISH MOUNT

VY4311A2 - 2 3/8" O.D.
VY4311A - 4 1/2" O.D.

MAST TUBE PROVIDED IS 5' LONG.

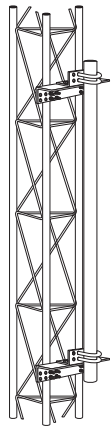

FACE MOUNT

DM45G2 - 2 3/8" O.D. 5' LONG
DM454 - 4 1/2" O.D. 5' LONG

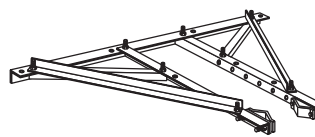

HEAVY DUTY UNIVERSAL
HOUSE BRACKET
HBUTVRO

ADJUSTABLE TO POSITION TOWER
18" - 36" FROM WALL.

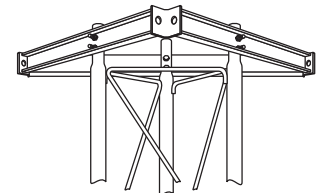

TORQUE ARM STABILIZER
ASSEMBLY
TA45



ANTI-TWIST DEVICE LOCATED IN THE
AREA OF ANTENNAS. PROVIDES SIX-WAY
GUYING. BOLTS TO TOWER AT ANY
SECTION JOINT. ATTACHED WITH
JOINT BOLTS. MUST BE INSTALLED AS
SECTIONS ARE JOINED TOGETHER.



* TOWERS MOUNTED ON THESE BASES MUST BE BRACKETED OR GUYED AT ALL TIMES. TEMPORARY STEEL GUYING MAY ALSO BE NECESSARY DURING INSTALLATION AND DISMANTLING.

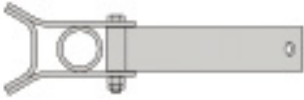
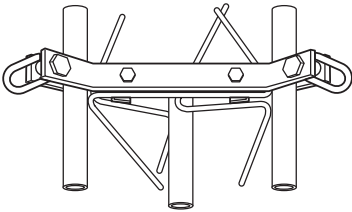
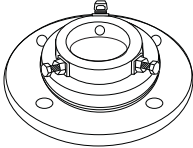
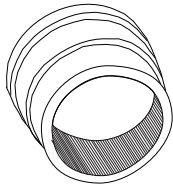

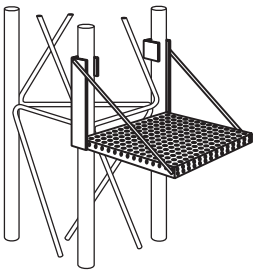
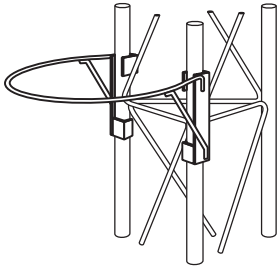
PARTS & ACCESSORIES

 <p>TORQUE BAR TB45D OPTIONAL, FOR USE WITH GA45GD. REQUIRES (1) 3/8" SHACKLE FOR EACH BAR.</p>	 <p>GUY BRACKET GA45GD MOUNTS TO TOWER AT ANY HORIZONTAL BRACE.</p>	 <p>THRUST BEARING TB3 - SUPPORTS UP TO 2" O.D. MAST. TB4 - SUPPORTS UP TO 3" O.D. MAST. MOUNTS TO BPL45G AND 45AG4.</p>	 <p>TOWER BUSHING TB50 - 1-1/4" I.D. X 2" O.D. FOR USE ON 45AG TOP SECTION</p>
---	---	---	--

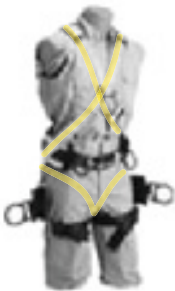
 <p>ANTI-CLIMB PANEL ACL455 THREE ANTI-CLIMB PANELS BOLT TO STANDARD TOWER SECTION.</p>	 <p>WORK PLATFORM WP45G SNAPS INTO PLACE AT ANY LEVEL. NO BOLTS REQUIRED.</p>	 <p>SAFETY RING SR245 SNAPS INTO PLACE AT ANY LEVEL. NO BOLTS REQUIRED.</p>	 <p>ERECTION FIXTURE EF2545 - 2 1/2" SHEAVE WITH 3/8" I.D. GROOVE. NOTE: ERECTION FIXTURES ARE FOR LIFTING ONE 10' SECTION AT A TIME AND ARE NOT INTENDED FOR THE LIFTING OF PERSONNEL.</p>
--	--	---	--

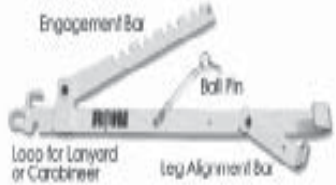
 <p>CLIMBING HARNESS TTFBH-4D JOURNEYMAN HARNESS TTFBH-C/P PROFESSIONAL HARNESS</p>	 <p>SAFETY CABLE SLIDER WITH CARABINEER TT-WG-500-W/SMC</p>	<p>SAFETY CABLE SYSTEM ORDERING INFORMATION</p> <table border="1"> <thead> <tr> <th>TOWER HEIGHT</th> <th>PART NUMBER</th> </tr> </thead> <tbody> <tr> <td>50'</td> <td>TT0504555</td> </tr> <tr> <td>100'</td> <td>TT1004555</td> </tr> <tr> <td>150'</td> <td>TT1504555</td> </tr> <tr> <td>200'</td> <td>TT2004555</td> </tr> <tr> <td>250'</td> <td>TT2504555</td> </tr> <tr> <td>300'</td> <td>TT3004555</td> </tr> <tr> <td>350'</td> <td>TT3504555</td> </tr> </tbody> </table> <p>SAFETY CABLE SLIDER AND CLIMBING HARNESS MUST BE ORDERED SEPARATELY.</p>	TOWER HEIGHT	PART NUMBER	50'	TT0504555	100'	TT1004555	150'	TT1504555	200'	TT2004555	250'	TT2504555	300'	TT3004555	350'	TT3504555	 <p>ASSEMBLY TOOL ROHNJACK Fits 25G, 45G, & 55G</p>
TOWER HEIGHT	PART NUMBER																		
50'	TT0504555																		
100'	TT1004555																		
150'	TT1504555																		
200'	TT2004555																		
250'	TT2504555																		
300'	TT3004555																		
350'	TT3504555																		



ANCHOR INFORMATION

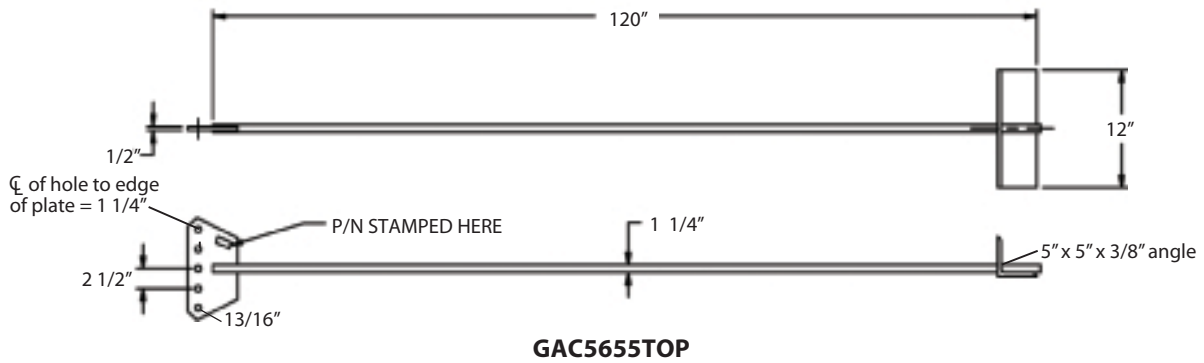
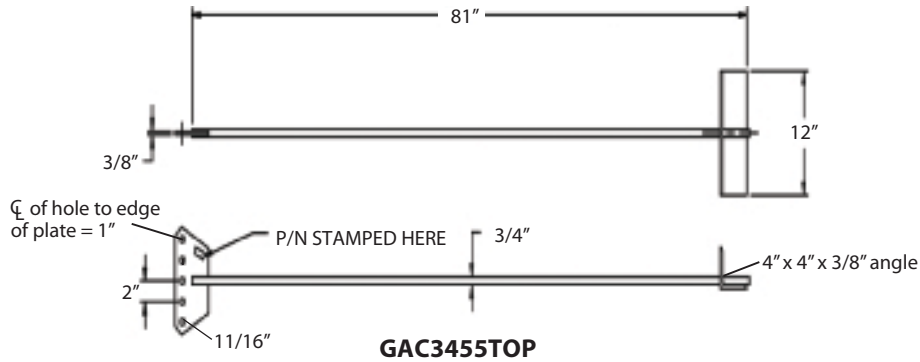

REV G
ANCHOR GROUNDING
AGK1GGX

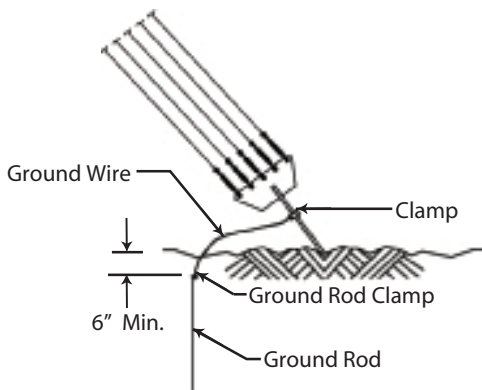

REV G
BASE GROUNDING
BGK3GGX

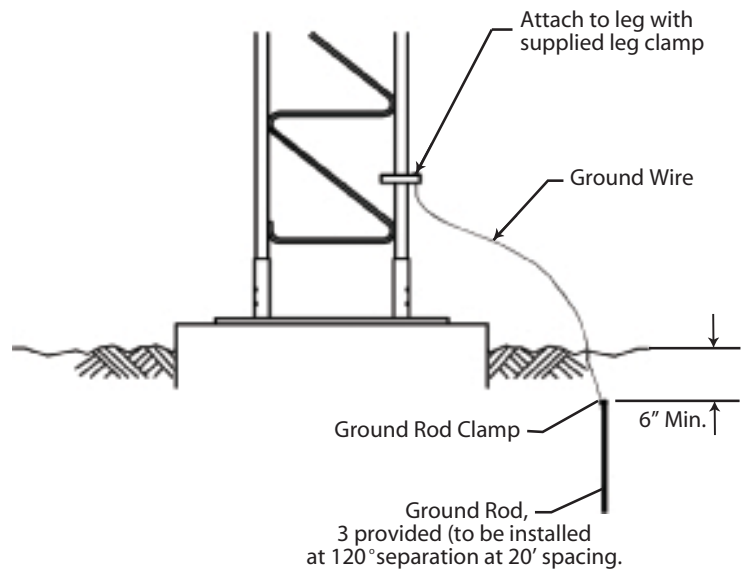

STANDARD ANCHOR BLOCKS

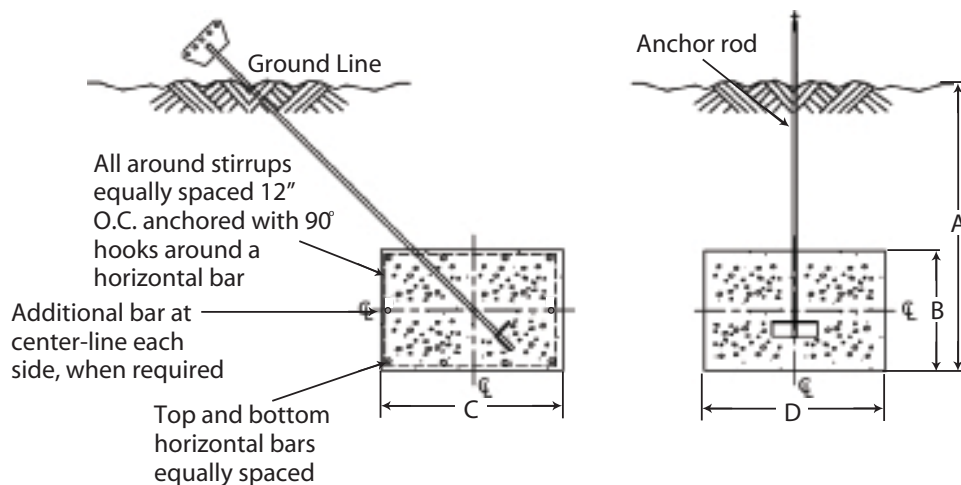

Refer to page 68 for anchor rod installation angles.

Block	Anchor Dimensions (in.)				Horizontal Bars (Qty. & Size)	Stirrup Size & Spacing	Concrete Vol. (Cu. Yds.)
	A	B	C	D			
AB1	3' - 0"	1' - 0"	3' - 0"	4' - 0"	(8) #5 Bars, Total (4) #5 Bars Top & Bottom Layers (0) Additional Bar, Each Side	#3 @ 12" O.C.	.044 Per Block 1.3 Total for 3
AB2	4' - 0"	1' - 6"	4' - 0"	6' - 0"	(5) #6 Bars, Top Layer (5) #6 Bars, Bottom Layer (0) Additional Bar, Each Side	#3 @ 12" O.C.	1.33 Per Block 4.0 Total for 3
AB3	6' - 0"	1' - 6"	3' - 0"	6' - 0"	(4) #6 Bars, Top Layer (4) #6 Bars, Bottom Layer (0) Additional Bar, Each Side	#3 @ 12" O.C.	1.0 Per Block 3.0 Total for 3
AB4	6' - 0"	1' - 6"	4' - 0"	9' - 0"	(5) #6 Bars, Top Layer (5) #6 Bars, Bottom Layer (0) Additional Bar, Each Side	#4 @ 12" O.C.	2.0 Per Block 6.0 Total for 3
AB5	8' - 0"	2' - 0"	3' - 0"	10' - 0"	(4) #7 Bars, Top Layer (4) #7 Bars, Bottom Layer (1) Additional Bar, Each Side	#4 @ 12" O.C.	2.22 Per Block 6.7 Total for 3
AB6	8' - 0"	2' - 0"	4' - 0"	10' - 0"	(5) #7 Bars, Top Layer (5) #7 Bars, Bottom Layer (1) Additional Bar, Each Side	#4 @ 12" O.C.	2.96 Per Block 8.9 Total for 3



ANCHOR ROD INSTALLATION ANGLES

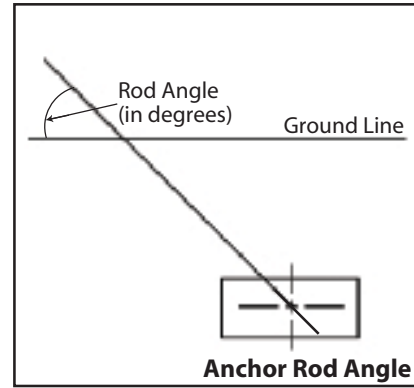
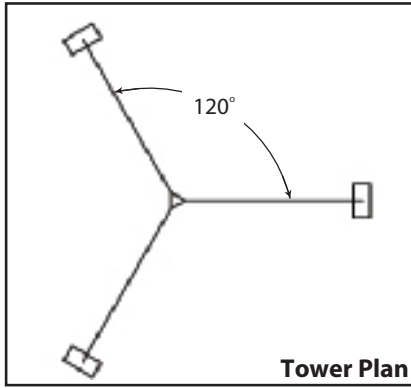

45G 90MPH				
Tower Height	Inner Rod Number	Inner Rod Angle	Outer Rod Number	Outer Rod Angle
40'	GAC3455TOP	45	-	-
50'	GAC3455TOP	46	-	-
60'	GAC3455TOP	43	-	-
70'	GAC3455TOP	43	-	-
80'	GAC3455TOP	41	-	-
90'	GAC3455TOP	42	-	-
100'	GAC3455TOP	42	-	-
110'	GAC3455TOP	40	-	-
120'	GAC3455TOP	39	-	-
130'	GAC3455TOP	40	-	-
140'	GAC3455TOP	39	-	-
150'	GAC3455TOP	38	-	-
160'	GAC3455TOP	37	-	-
170'	GAC3455TOP	38	-	-
180'	GAC3455TOP	38	-	-
190'	GAC3455TOP	36	-	-
200'	GAC3455TOP	36	-	-
210'	GAC3455TOP	40	GAC3455TOP	44
220'	GAC3455TOP	40	GAC3455TOP	44
230'	GAC3455TOP	42	GAC3455TOP	42
240'	GAC3455TOP	42	GAC3455TOP	41
250'	GAC3455TOP	40	GAC3455TOP	43
260'	GAC3455TOP	40	GAC3455TOP	42
270'	GAC3455TOP	38	GAC3455TOP	43
280'	GAC3455TOP	38	GAC3455TOP	43
290'	GAC3455TOP	38	GAC3455TOP	44
300'	GAC3455TOP	38	GAC3455TOP	43

45G 110MPH				
Tower Height	Inner Rod Number	Inner Rod Angle	Outer Rod Number	Outer Rod Angle
40'	GAC3455TOP	45	-	-
50'	GAC3455TOP	46	-	-
60'	GAC3455TOP	41	-	-
70'	GAC3455TOP	41	-	-
80'	GAC3455TOP	41	-	-
90'	GAC3455TOP	41	-	-
100'	GAC3455TOP	39	-	-
110'	GAC3455TOP	39	-	-
120'	GAC3455TOP	39	-	-
130'	GAC3455TOP	38	-	-
140'	GAC3455TOP	38	-	-
150'	GAC3455TOP	38	-	-
160'	GAC3455TOP	38	-	-
170'	GAC5655TOP	37	-	-
180'	GAC5655TOP	37	-	-
190'	GAC5655TOP	37	-	-
200'	GAC5655TOP	37	-	-
210'	GAC3455TOP	41	GAC5655TOP	42
220'	GAC3455TOP	41	GAC5655TOP	42
230'	GAC3455TOP	38	GAC5655TOP	43
240'	GAC3455TOP	39	GAC5655TOP	43

45G 130MPH		
Tower Height	Rod Number	Rod Angle
40'	GAC3455TOP	48
50'	GAC3455TOP	48
60'	GAC3455TOP	40
70'	GAC3455TOP	40
80'	GAC3455TOP	40
90'	GAC3455TOP	40
100'	GAC3455TOP	38
110'	GAC3455TOP	38
120'	GAC3455TOP	38
130'	GAC5655TOP	38
140'	GAC5655TOP	37
150'	GAC5655TOP	37

STANDARD BASE PIERS

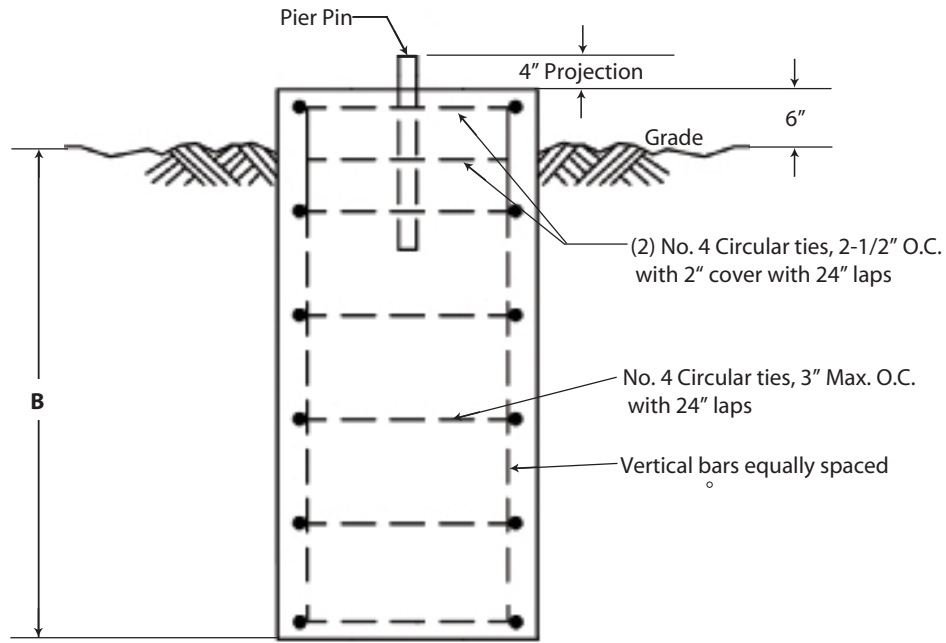

ELEVATION VIEW

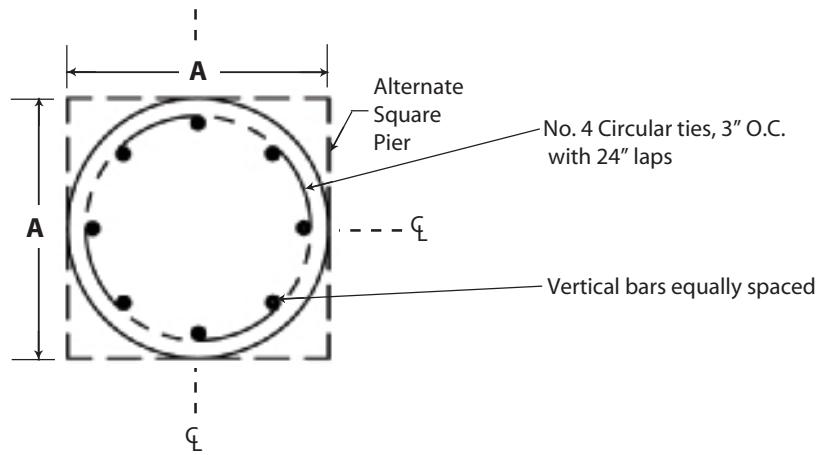

PLAN VIEW

Base	A	B	Concrete Vol. (Cu. Yds.) Round Pier	Vertical Bars (No. & Size)
CB1G*	2' - 6"	4' - 0"	1.0	(8) #7
CB2G	3' - 0"	4' - 0"	1.2	(10) #7
CB3G	3' - 6"	4' - 0"	1.6	(12) #7

* Square pier option must be used for CB1G.