

4.9 GHz to 6.4GHz, 1-Foot Parabolic, Ubiquiti Rocket Prism Gen 2 Adapter

KP-5PDRPG2-1



Features

- This antenna includes the KP-5PDA-UPRG2 radio adapter
- Stable gain and patterns over ultra-wide bandwidth of 4.9 - 6.4 GHz
- Optimized F/B & side-lobe suppression minimizes interference
- Quick connect waveguide allows rapid change of polarization and installation
- Installs in minutes to reduce service calls and installation time
- Integrated handle / hoisting hook for added safety and convenient installation
- Heavy-duty bracket with fine elevation and azimuth adjustment beamwidths
- Adjustable horizontal / vertical or $\pm 45^\circ$ slant polarization that is compatible with all 5 GHz CPE radios
- Quick-connect waveguide allows polarization to be adjusted and quick change of adapters without tools
- Mounts to any size mast from 0.75" to 4.5"

Applications

- Wireless MIMO LAN systems & IEEE 802.11n applications
- Point-to-point (PtP) for backhaul or client premise equipment (CPE)
- Supports public safety (4.9 GHz), U-NII-1, 2, 3, and 4 (5.15-5.925 GHz), and up to 6.4GHz for world-wide market
- Mobile WiMAX Wireless Internet Provider "cell" sites
- High-density deployments requiring frequency reuse to achieve high capacity and data rates
- Last-mile connection

Description

The KP-5PDRPG2-1 is a 1-foot, 24 dBi parabolic antenna operating from 4.9 GHz to 6.4GHz. This antenna includes the KP-5PDA-UPRG2 radio adapter which is designed specifically for the Ubiquiti Rocket Prism 5AC and 5AC Gen 2 radios.

This 1-foot 5GHz ProLine Parabolic Antenna is engineered to suppress side-lobes and back-lobes and is excellent at rejecting interference. With this antenna's over 24 dBi gain and 35 dBi front to back ratio, the operator will maximize the potential of the radio by improving signal strength and reducing the noise floor in the point-to-point (PtP) link. Our parabolic antennas are perfectly suited for high density PtP client-premise equipment or backhaul applications. Their port isolation and cross polarization are over 25 dB which is essential in maximizing throughput from multi input multi output (MIMO) multiplexing schemes.

The KP-5PDRPG2-1 features high-grade, powder-coated aluminum reflector, mounting brackets, and hardware which allow up to 20 degrees of azimuth and elevation mechanical tilt and supports pole diameters of 0.75 in to 4.5 in. These rugged antennas are built a grade above the rest and rated to survive up to 125mph. The reflectors are made from dent-resistant, high grade aluminum that is powder-coated a light-grey color. The antennas integrated and removable red handle can be used to carry or hoist the antenna for safer installation. The quick connect waveguide allows changing out the adapter for quick radio swap outs without the need to remove the antenna or tools. The antenna supports both Horizontal/Vertical and Dual +/- 45 Degree Slant polarization schemes which can be changed in the field through a simply rotation of the adapter.

The KP-5PDA-URPG2 is a push-in adapter that features simplified installation with patented, quick-connect waveguide technology to the antenna and a durable housing to snap in the radio without any additional cables or taping. The weatherproof adapter is built to withstand challenging environments subject to intense UV, rain, snow, and ice and is highly reliable over a longer product lifetime.

Configuration

Application Band	5 GHz
Band Type	Single
Radiation Pattern	Directional
Polarization	H/V or 45 Deg. Slant
Number of Ports	2

Click the following link (or enter part number in "SEARCH" on website) to obtain additional part information including price, inventory and certifications:
[4.9 GHz to 6.4GHz, 1-Foot Parabolic, Ubiquiti Rocket Prism Gen 2 Adapter KP-5PDRPG2-1](#)

4.9 GHz to 6.4GHz, 1-Foot Parabolic,
 Ubiquiti Rocket Prism Gen 2 Adapter

KP-5PDRPG2-1



Lightning Protection
 Housing Material and Plating

RF connector grounded to mounting bracket
 Anodized Aluminum, Powder Coat

Electrical Specifications

Description	Minimum	Typical	Maximum	Units
Frequency Range	4.9		6.4	GHz
Input VSWR		1.5:1		
Impedance		50		Ohms
Input Power			100	Watts

Specifications by Band

Description	Band 1	Band 2	Band 3	Band 4	Band 5	Units
Range	4,900-5,400	5,400-5,900	5,900-6,400			MHz
Gain	22.5	24	24.5			dBi
Horizontal HPBW	10	8.8	8			Degrees
Vertical HPBW	10.1	8.7	7.9			Degrees
Cross Polar Ratio HPBW	25	25	25			dB
Port Isolation	30	30	23			dB
Front to Back Ratio	35	35	35			dB
VSWR Max	1.7:1	1.5:1	1.8:1			

Mechanical Specifications

Housing Material	Anodized Aluminum
Housing Plating/Color	Powder Coat
Size	
Length	15.5 in [393.7 mm]
Width	15.5 in [393.7 mm]
Height	18.7 in [474.98 mm]
Mounting Mast Diameter	0.75 to 4.5 in [19.05 to 114.30 mm]
Weight	12 lbs [5.44 kg]

Environmental Specifications

Temperature	
Operating Range	-40 to +60 deg C
Wind Survivability	125 MPH [201.17 KPH]
Wind Loading	Frontal, 146 lbf

Click the following link (or enter part number in "SEARCH" on website) to obtain additional part information including price, inventory and certifications:
[4.9 GHz to 6.4GHz, 1-Foot Parabolic, Ubiquiti Rocket Prism Gen 2 Adapter KP-5PDRPG2-1](#)

4.9 GHz to 6.4GHz, 1-Foot Parabolic, Ubiquiti Rocket Prism Gen 2 Adapter

KP-5PDRPG2-1



Plotted and Other Data

Notes:

Typical Radiation Pattern

Azimuth Pattern

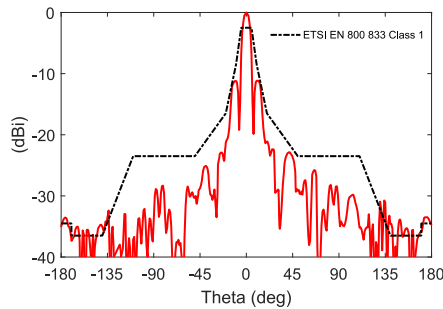
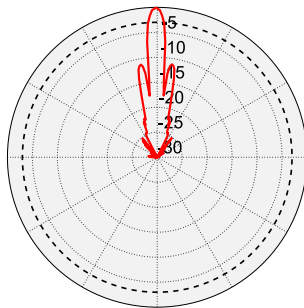

Gain

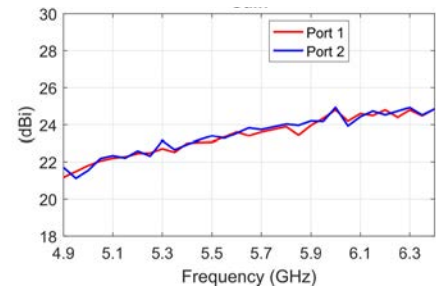

Elevation Pattern

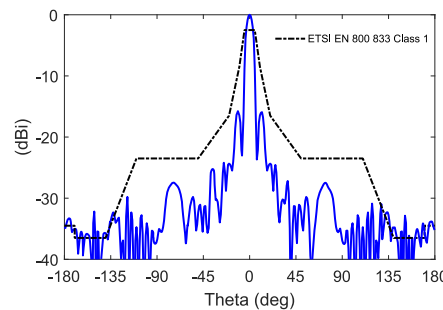
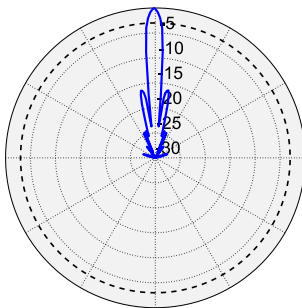

VSWR

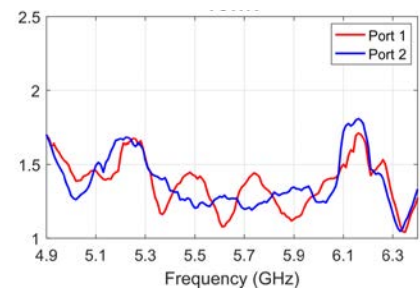

Click the following link (or enter part number in "SEARCH" on website) to obtain additional part information including price, inventory and certifications:
[4.9 GHz to 6.4GHz, 1-Foot Parabolic, Ubiquiti Rocket Prism Gen 2 Adapter KP-5PDRPG2-1](#)

4.9 GHz to 6.4GHz, 1-Foot Parabolic, Ubiquiti Rocket Prism Gen 2 Adapter

KP-5PDRPG2-1



Appendix

Electrical Downtilt: Angle in the antenna's elevation pattern in which the maximum gain occurs.

Gain: Antenna's average gain.

Front to Back Ratio @ 180°±30°: Average difference between the antenna's maximum gain and the maximum gain in the antenna's back lobe over ±30° angles.

Cross-polarization Ratio (dB): Typical difference between the co-polarization and cross-polarization gain across the sector's 3 dB Beam Width.

Dedicated to serving the needs of the Wireless Internet Service Provider (WISP) market, KP Performance Antennas offers purpose built products that reliably perform in the field. KP Performance Antennas product line consists of Yagi, Grid, Omni, Dish and other style antennas that operate in the 900 MHz, 2.4 GHz, 3 GHz, and 5 GHz frequencies.

Click the following link (or enter part number in "SEARCH" on website) to obtain additional part information including price, inventory and certifications: [4.9 GHz to 6.4GHz, 1-Foot Parabolic, Ubiquiti Rocket Prism Gen 2 Adapter KP-5PDRPG2-1](https://www.kpperformance.com/4.9-ghz-to-6.4ghz-1-foot-parabolic-ubiquiti-rocket-prism-gen-2-adapter-kp-5pdrpg2-1-p.aspx)

URL: <https://www.kpperformance.com/4.9-ghz-to-6.4ghz-1-foot-parabolic-ubiquiti-rocket-prism-gen-2-adapter-kp-5pdrpg2-1-p.aspx>

The information contained within this document is accurate to the best of our knowledge and representative of the part described herein. It may be necessary to make modifications to the part and/or the documentation of the part in order to implement improvements. KP Performance reserves the right to make such changes as required. Unless otherwise stated, all specifications are nominal. KP Performance does not make any representation or warranty regarding the suitability of the part described herein for any particular purpose, and KP Performance does not assume liability arising out of the use of any part or document.

4.9 GHz to 6.4GHz, 1-Foot Parabolic, Ubiquiti Rocket Prism Gen 2 Adapter

KP-5PDRPG2-1 CAD Drawing

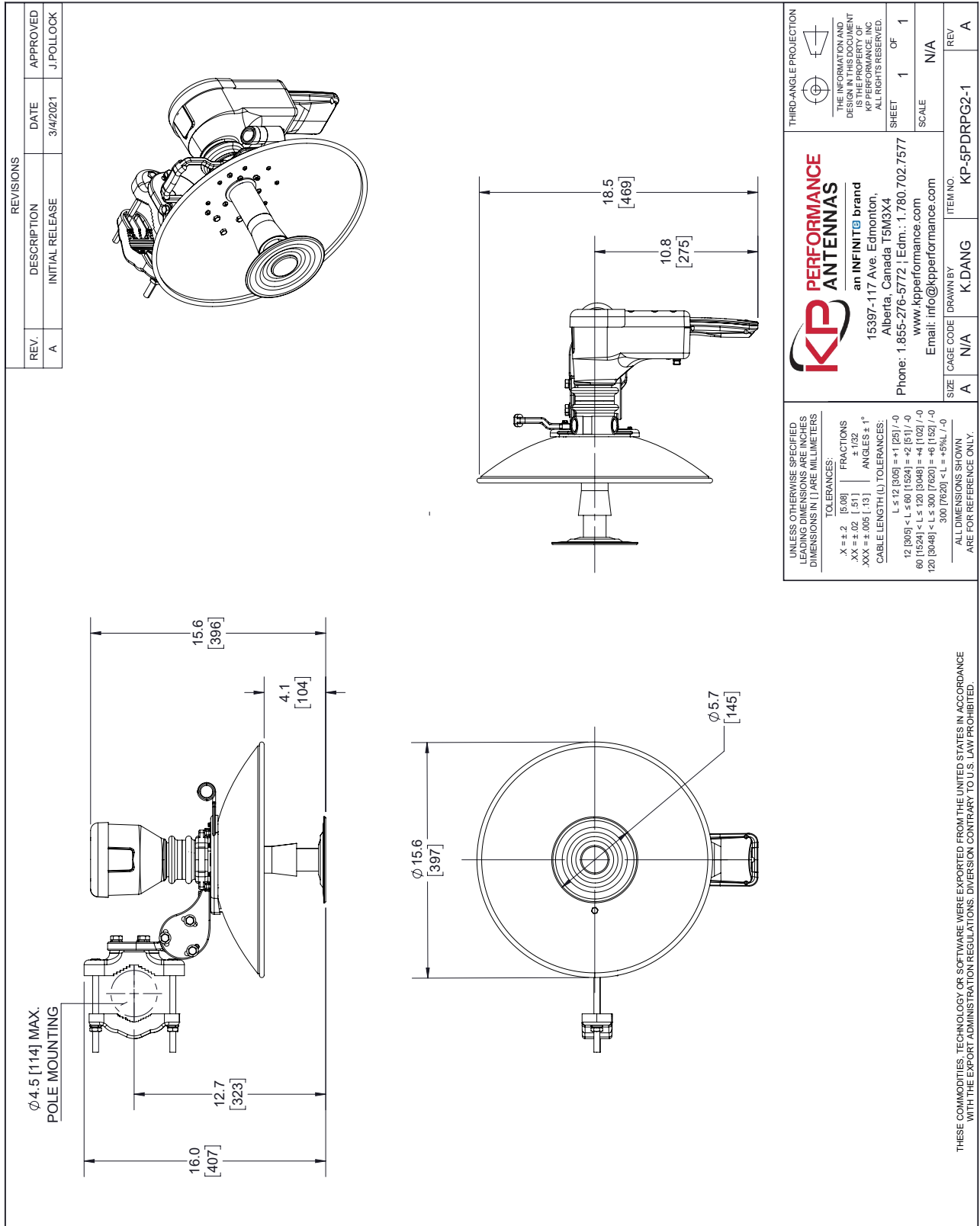

KP PERFORMANCE ANTENNAS
an INFINIT@ brand

15397-17 Ave. Edmonton,
Alberta, Canada T5M3X4
www.kpperformance.com
Email: info@kpperformance.com

Phone: 1.855-276-5772 | Edm.: 1.780.702.7577

THIRD-ANGLE PROJECTION

THE INFORMATION AND DESIGN ARE THE PROPERTY OF KP PERFORMANCE, INC. ALL RIGHTS RESERVED.

SHEET 1 OF 1

SCALE N/A

SIZE	CAGE CODE	DRAWN BY	ITEM NO.
A	N/A	K.DANG	KP-5PDRPG2-1
			REV
			A